



M series/H series/S series/F30/F35

POWER HARROWS

WHEN FARMING MEANS BUSINESS

Realising the full potential of farming is about growing and developing your business, not only your crop or livestock, but also your profit. Improve productivity and profitability by focusing on the positives and minimising disadvantageous aspects, through strong, dedicated management.

Success springs from determination and clear targets, from laying down the appropriate strategy and allocating correct investments for the future. Quality results require the right ideas and equipment. When there is work to be done, you need the optimal setup and smart solutions that support you towards an easier, more profitable way of working. You need solutions that make tough and demanding conditions less complicated.





TILLAGE

Preparing and cultivating your soil in order to achieve the highest possible yield is about choosing the correct tillage system.

YOUR KVERNELAND

INTELLIGENT FARMING SOLUTIONS

Choose the best farming solution for you and your land. Combine the highest possible yields with sustainability. This will start with the correct tillage. The choices you make depend on various factors and should match your specific circumstances, like soil structure, crop rotation, residue management, economic and ecological viabilities.

The choice is yours!

You must consider environmental and legal issues. From conventional methods to conservation tillage: the balance of operations at the right time has to be found to achieve high yields with the best soil condition (air, moisture, biological activity, etc.) with a minimum amount of energy, time and investment. For this, Kverneland offers a full range of intelligent farming solutions.

CONVENTIONAL TILLAGE

Conventional Tillage

- **Intensive** method of cultivation
- Complete soil inversion e.g. by a plough
- Less than 15-30% crop residues left on soil surface
- Seedbed preparation done by an active tool or special seedbed harrow
- High phytosanitary effect by reduced pressure of weed and fungi diseases - fewer herbicides and fungicides needed
- Better dry-off and faster increase of soil temperature for better nutrients absorption

CONSERVATION TILLAGE

Mulch Tillage





















- **Reduced** intensity in terms of depth and frequency
- More than 30% of residues are left on soil surface
- Extended repose period of the soil
- Cultivator and/or discs incorporate the crop residues within the top 10cm of soil for stable bearing soil
- Full-width tillage - seedbed preparation and seeding in one pass
- Protection against soil erosion; reduce soil loss by run-off and improve water storage capacity.
- Improvement of soil moisture retention

Strip Tillage

- **Zonal strip loosening** before or during seeding of up to 1/3 of the row width (Loibl, 2006). Up to 70% of the soil surface remains untouched
- Strip-till combines the soil drying and warming benefits of conventional tillage with the soil-protecting advantages of no-till by disturbing only the area of the soil where the seeds are placed
- Exact fertilising deposit
- Soil protection against erosion and drought

Vertical Tillage / No-Till

- **Extensive** method
- Working soil vertically avoids additional horizontal layers or density changes
- Increasing water infiltration, root development and nutrient take-up
- Plants' roots dictate the overall health of the plant, as they deliver nutrients and water throughout the season, contributing to a higher yield
- A strong set of roots make plants more resistant to wind and drought.
- Lower energy input required

KVERNELAND'S INTELLIGENT FARMING SOLUTION			Deep Tillage (not a must)	Basic Tillage	Seedbed Preparation	Seeding	Spreading	Spraying
CROP ESTABLISHMENT SYSTEMS	CONVENTIONAL			  	 	 	 	  
	intensive							
CONSERVATION		Soil coverage after Seeding						
extensive		> 30%	15 - 30%					
		Vertical Tillage shallow tillage	Strip Tillage stripwise loosening	Mulch Seeding without soil inversion	Reduced Till without soil inversion	Conventional with soil inversion		

CLASSIFICATION OF TILLAGE METHODS KVERNELAND (Source: adapted from KTBL)

RELIABLE

EFFICIENT

POWERFUL

STRONG



KVERNELAND POWER HARROWS YOU CAN RELY ON!

Powerful

You want a perfectly levelled seedbed to give your crop good starting conditions. Smooth running of the power harrow is the base for best performance. Kverneland power harrows are all equipped with 4 rotors per metre of trough and helical tine positioning. Preparing the basis for your yields.

Strong

You want a machine that lasts, that copes with the stress on the material over a long time. Still, you don't want extra weight. That's why Kverneland has developed the machines with the self-supporting trough and close centre of gravity. Less lifting force needed means saving on fuel costs.

Efficient

When the time is right you want to act immediately. Tomorrow, conditions may be worse. Seedbed preparation and seeding in one pass saves time and fuel. It relieves your time pressure. In addition, you are versatile for all conditions. The active tool is intended for ploughed land or mulch conditions.

Reliable

You are always prepared because it is nearly all maintenance free. The tines can therefore be exchanged quickly without any tools. Special emphasis has been given to reliability and a strong trough design. All Kverneland power harrows are made in Germany.

Power up – solo or in combination



25CM
ROTOR
DISTANCE

WHY POWER HARROWING? FOR SUCCESSFUL GERMINATION

An optimal seedbed with a load-bearing seed horizon into which the seeds can be embedded at an absolutely even depth over the whole area of the field is the basis for high field emergence and thus for high yields. It requires an unbroken association between the seed horizon and the capillary water conducting lower layer to ensure germination in the absence of rainfall. Additionally, rapid heating of the soil and adequate oxygen supply to the germination seeds and a fine crumbled and uniform reconsolidated seedbed for an optimal seed coverage is important too.

Power harrows have long since become typical combination machines because they are largely independent of the soil conditions. On heavy soils it reaches an intensive crumbling. Under light conditions, it can work flat and at a lower rotor speed. The sets of tines rotate on vertical axles for totally horizontal tillage of the soil – no inversion of soil layers and no vertical compression leading to hardpan formation. Consequently, there is no better alternative for seedbed preparation.

A perfect seedbed is the basis for high yields.

A power harrow together with a seed drill is finally an economic high performance combination. Seed bed preparation and seeding in one pass!

All Kverneland power harrows models are exclusively designed to be combined with Kverneland seed drills either modular with front tank and coulterbar or with cultivator mounted seed drills.

Perfect Seedbed

- **Uniform distribution of plant residues (influences lighting conditions and nutrient reservoir).**
- **No deep tracks or compacted zones in the ground.**
- **Constant working depth, avoidance of unnecessarily deep cultivation.**
- **Soil structuring with fine soil in the sowing horizon and coarser crumb structure at the surface to achieve a weatherproof finish.**

QUALITY THAT LASTS!

ACTIVE INTENSIVE SEEDBED PREPARATION

Kverneland power harrows have a self-supporting trough, therefore a heavy frame is not necessary. The power harrows are a successful and tested construction principle for heavy duty operations. The advantages are compelling: High stability for the whole working width, the rotor drive is isolated from distortion or bending stresses. All mechanical stresses are transferred directly on to the shock absorbing headstock.

One concept - That fits together!

1

Self-supporting trough

Strong resistance to abrasion and torsion is one of the main characteristics of the double bending trough in sandwich design. The "laminated bottom" and the wide, wear-resistant gear profile ensure reliable heavy-duty use. The tapered bearings have a high basic load rating which offers increased security and reliability, giving an extended working life.

2

Tine holder & Tine

First priority is durability and protection against stones and good access. The rotor shaft and tine holder consist of two parts for easy maintenance and long-lifetime, even in stony conditions. Very important - the tines are easy to change due to the Quick-Fit system. The two large bearings are very strong and the

large distance between the bearings ensure maximum resistance to radial stress, even in the most extreme conditions. The forged boron steel tines prepare the seedbed by cutting, crumbling and levelling the ground. The tines are extremely hard wearing and fracture-resistant. The outer tines turn inwards, which together with the side deflectors avoid ridge formation. An important characteristic is the helical tine positioning which minimises the risk of damage (from stones) and ensures a more homogeneous and even load on the trough. In addition, this special design also reduces the amount of wet soil brought to the surface (especially important in the spring time); the moisture stays next to the seed for improved germination.

3

Rotor clearance

Four rotors (8 tines) per metre ensures coverage of the entire working width. This represents an optimum number for thorough crumbling of the soil. Minimal torque on drive gears means minimal wear.

4

Robust headstock

The headstock is very strong due to the use of thick-walled steel offering several possibilities for combining with mounted and semi-mounted seed drills. The length thus optimising weight transfer.

5

Roller

The final step of perfect seedbed preparation is consolidation. A weatherproof finish allows moisture retention when dry and transition (water infiltration) through the profile in wet conditions.

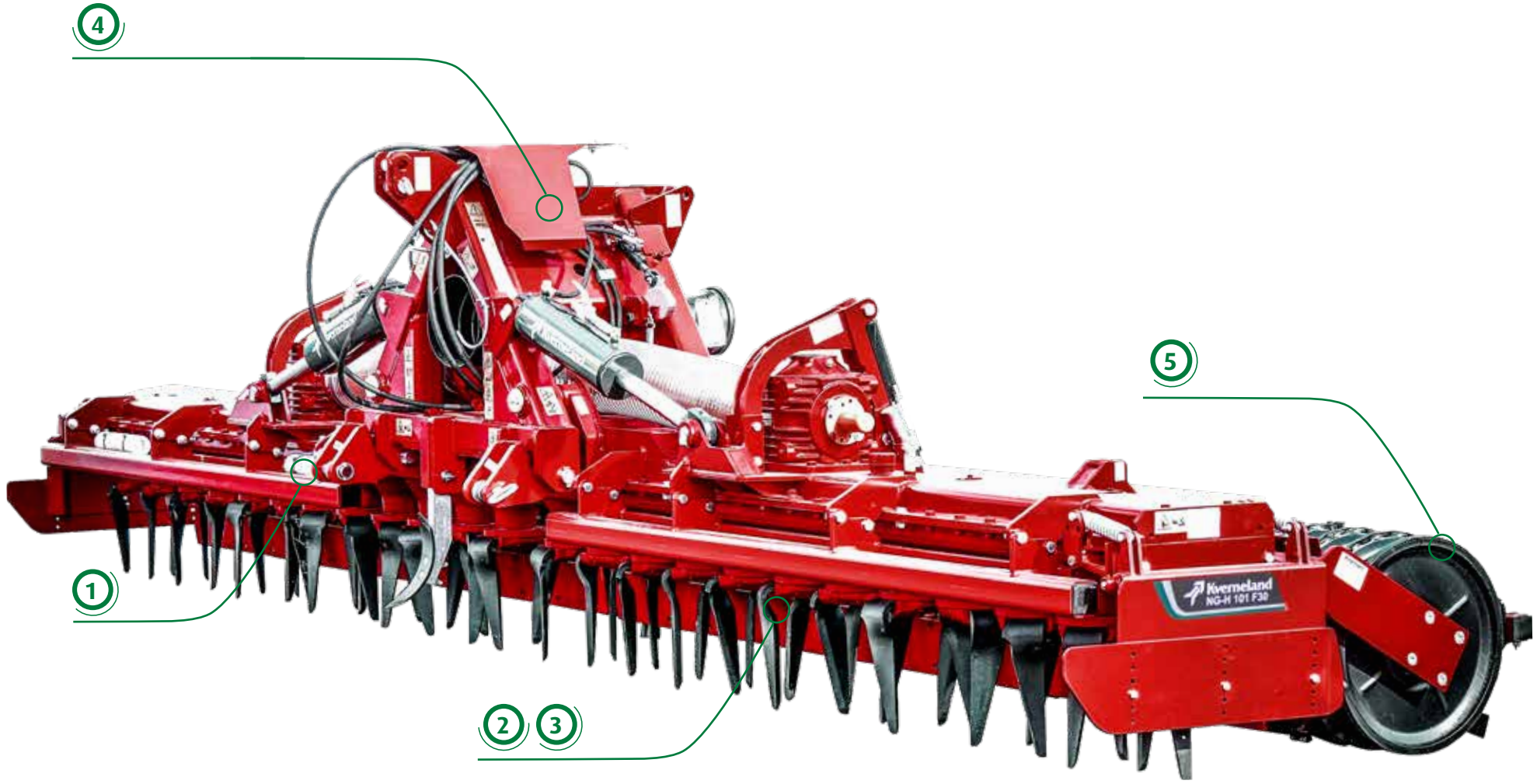

STRENGTH AND POWER FOR LONGER DURABILITY

Sophisticated technologies are used for each development such as static load test, finite elements method (FEM), 100% check of bearings and gears with PTO drive during assembly and random stress-tests in the stone pitch. High quality components like hardened gears with optimum distances and dimensions are taken to achieve best working results in all conditions.

Proven Reliability - Made in Germany!

Finally, the machines are tested in the field under different conditions to reconfirm that the requirements to all functions and strength are met. "We are testing according to a strict LOR and test protocol which are defined to meet all kind of soil conditions" mentioned Rainer Schauer, team leader industrialisation.

Gregor Kottenstedde, engineer of the power harrows added that the complete power harrow range has been designed to be combined with the Cracker packer or Actipack roller, which are the heaviest rollers in the range. "We considered all the most aggressive scenarios like deep working when turning, combination with seed drills or coulter bars as well as random stress tests in stone pitch to make the different power harrow models as strong as possible. And this is guaranteeing the proven Kverneland quality".







Helical tine positioning

The tines are arranged in varying angle positions in order to prevent damage caused by stones and ensure even levelling. 4 rotors per meter and the helical tine positioning reduce the peak loads on the driveline which results in smoother running and less fuel consumption. All gears are hardened in the trough for a long lifetime.

LONG LIFETIME

ROBUST TROUGH AND TRANSMISSION

For optimum performance in difficult soil conditions, the robust, self-supporting trough design provides a large clearance between the tine holder and trough bottom. Large amounts of residues and stones can pass freely without blocking and provides excellent results in mulch conditions.

Robust but less weight.

The trough, which is the backbone of the whole machine is extremely rigid against bending and torsional stress. On the H and S series also on the F30 the trough is made as a sandwich double bending beam to give additional stability. With this new trough and headstock design the weight of the S series is reduced by 15% compared to the former model. There are differences in dimensions between the models, but the headstock is the same on all models and absorbed together with the trough all mechanical forces.

Special emphasis has been given to reliability. This has been achieved by having a large distance between the conical bearings, hardened gears inside a stable gearcase, precise distance between the gears and the heavy-duty rigid trough design. The robust headstock for easy connection to all tractors and combination with heavy seed drills ensures safe working.

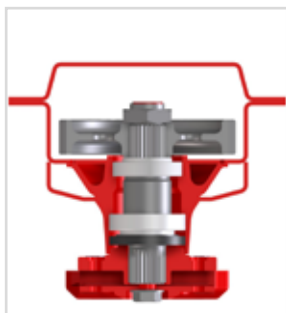

Model	Trough	Trough profile	Trough dimension (mm)	Gears	Ø Shaft (mm)	Bearings (mm)	Bearing distance (mm)	Rotor clearance (mm)
M series	rigid	bended plate bolted with reinforcement plate	140 x 400	tempered	40 & 45	80-90	70	98.25
H series	rigid	6mm sandwich profile with reinforcement plate	165 x 400	tempered & hardened	45 & 50	90-100	84.5	90,5
S series	rigid	6mm sandwich profile with reinforcement plate	200 x 400	hardened	55 & 60	110-120	110.5	100
F30	fold	6mm sandwich profile with reinforcement plate	150 x 400	tempered & hardened	45 & 50	90-100	84.5	90,5
F35	fold	2x 10mm profiled plates	150 x 400	hardened	55 & 60	110-120	110.5	147

OPTIMUM PENETRATION WITH STANDARD AND ACTIVE TINES

All models can be fitted with Standard and Active tines (active tines not on M series) as well as with the proven Quick-Fit system to meet customer demand for efficiency. The Quick-fit tines are secured by a special pin and clip mounted in the tine holder. The tines can therefore be exchanged quickly without any tools.

The **Active tines** ensure optimum penetration in hard or not cultivated soil. The tine, due to its shape, pulls itself into the ground. This gives a constant working depth and also prevents the machine from lifting out of the ground in hard dry soil conditions. In addition, it creates additional recompaction at the packer roller. The Active tine lifts the material and pushes it in front of the power harrow. This gives an optimum levelling effect even in tractor tracks. In mulch conditions the active tines can work directly into stubble and hard soil. The special shape of the tines keeps residues on the surface and this gives a big advantage against erosion.

Maximum resistant again radial stress

Kverneland has designed the tine carrier as wide as possible in order to reduce the loads and protect the tines and the holder.

Active tines (Option)

The special shape of the active tines ensure good penetration. The Active tines lift the soil and throw the clods as well as the plant residues into the front working zone. This ensures a perfect levelling even in the tractor tracks and leaves a stable crumbling structure.



Standard



Active



Carbide coated



XHD Carbide

XHD tines (Option)

The XHD Carbide reinforced tines are your perfect weapons against extremely abrasive soil conditions. These tines are designed to offer you longer lifetime, keeping costs and downtime to a minimum in environments where standard tines are wearing too fast. Available as spare part.



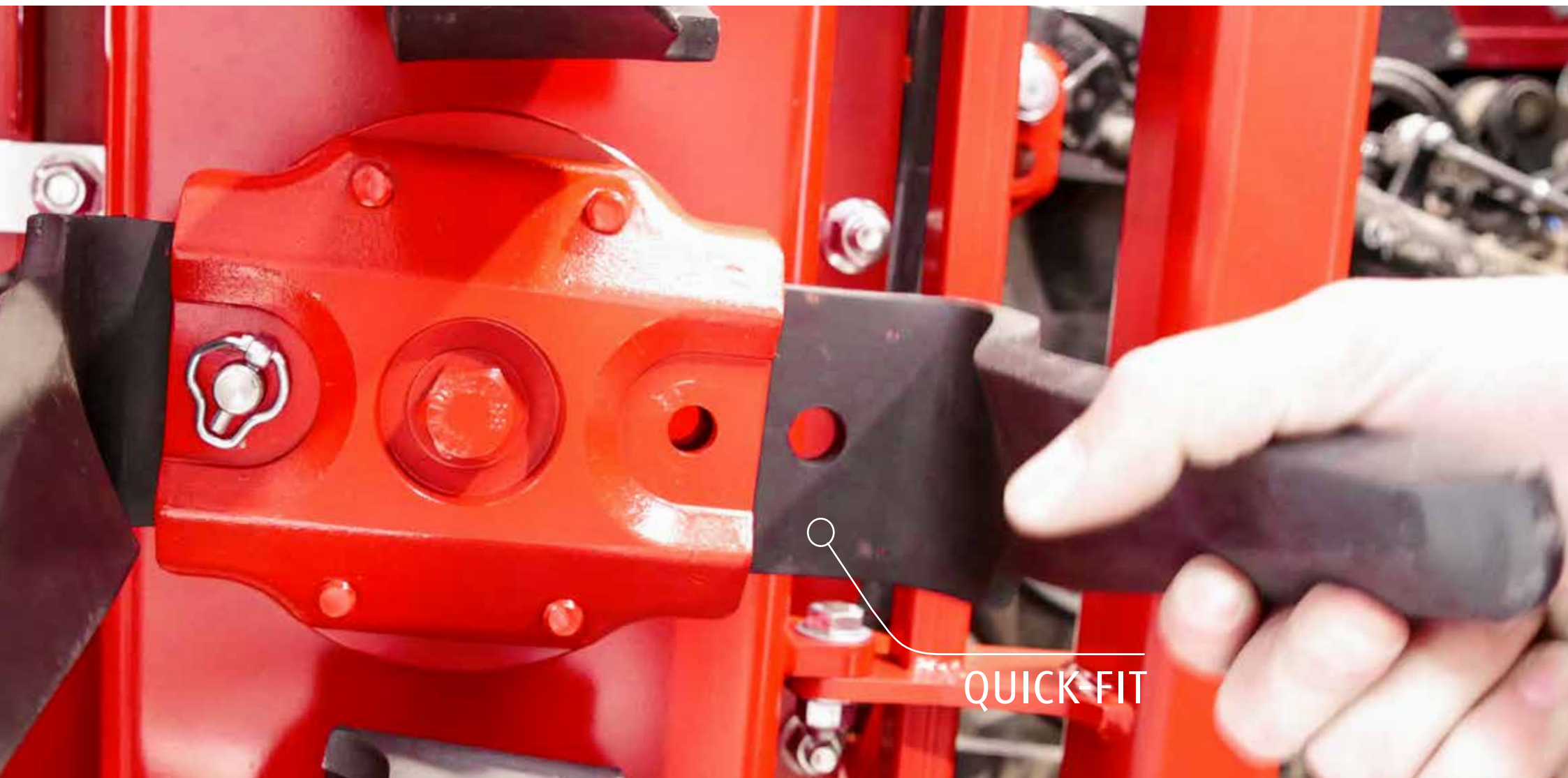

QUICK FIT

PERFECT LEVELLING

LEAVING AN EVEN SEEDBED

In order to create an even surface for a fine seedbed, Kverneland offers different options: a levelling bar, side deflectors and track eradicators.

When it comes to avoiding dams and to leave the soil as long as possible in the working area the parallelogram guided **side deflectors** move vertically up and down following the ground contours. If stones are trapped between deflector and outer rotor, the deflector can open via coil spring overload protection. The lower part is adjustable in height to match the tine wear. For strict transport regulations, the deflectors can easily be set in a raised transport position, just by removing one pin.

Kverneland's rear **levelling bar** is infinitely height adjustable. The turnbuckle adjustment is easy to use, even with a seed drill mounted. A scale ensures an even height across the full working width. An in-built spring system maintains the bar in an effective and consistent operating position. Recommended when working on heavy, cloddy ground or at very shallow depth.

Various types of **track eradicators** rigid, spring or shear bolt protected are available to suit all situations.







EASY TO USE - EASY TO MAINTAIN FOR PERFECT WORKING RESULTS

In conventional and conservation tillage processes, in solo use and in combination with seed drills or subsoilers - a powerful power harrow can be used in many ways. The combination of working depth, rotation speed and rotation direction of the tines makes it possible to create a fine-crumble and even seedbed under almost all conditions.

Kverneland has focussed on ease of maintenance. The trough is filled with special grease to ensure positive rotor lubrication from initial start up. The tine carrier design is of two separate pieces, allowing the oil seal to be replaced without opening the trough. The rotors are sealed with cassette seals, ensuring no wear on the shaft and minimum maintenance.

Time saving settings with minimal maintenance.

On the rigid power harrows the working depth is adjusted via pin and holes. A square pin avoids rotations and ovalization and the wide contact area, minimize wearing. 18 different slots for several working depths are available. The reinforced roller arms support stability with heaviest rollers and seeders.



On the hydraulic foldable power harrows the working depth setting is adjusted by spacers at the cylinders. The working depth is changed hydraulically from cab. A parallelogram linkage ensures that the power harrow is always in a horizontal position to the roller. Therefore, the packer roller scraper bar position is basically a fixed height to the ground, independent from the working depth.

EFFECTIVE IN COMBINATION

FLEXIBLE WITH QUICK COUPLING SYSTEMS

All Kverneland power harrows can be combined with Kverneland mounted pneumatic or mechanical seed drills or coulters bars with front hopper system.

Despite the integrated concept of a power harrow seed drill combination, the coulters bar can be coupled or uncoupled quickly via EURO-CONNECTION coupling system. Allowing the power harrow also to be used solo.

Flexibility is key!

The coulters bar is attached with the EURO-CONNECTION directly to the roller frame. The coupling hook is similar to the front loader coupling. This can quickly and easily be hitched thanks to the readily accessible hydraulic and electronic interface. Track markers are attached to the power harrow. The seed hopper can be removed too. Therefore, the power harrow is ready for solo operation within short time.

Alternative coupling systems like a hydrolift in order to combine the power harrow e.g. with a precision seeding unit, a triangle quick hitch or an mechanical hitch are available as an option.

Combination	M	H	S	F30	F35
DA	●	●	●	-	-
s-drill	●	●	●	-	-
e-drill compact	●	●	●	-	-
e-drill maxi	-	●	●	-	-
e-drill maxi plus	-	●	●	-	-
DF1 coultersbar	●	●	●	●	-
DF2 coultersbar	-	-	-	●	●
DFC coultersbar	-	-	-	●	●

● Possible - Not available



Flexible use of the power harrow whether with seed hopper or in solo operation depending on soil conditions.



Hydrolift

The hydrolift is fitted with twin hydraulic cylinders for easy and even lifting of heavy hoppers. A mechanical locking device ensures safe transport.



Quick-hitch

All models can be fitted with a Kverneland seed drill quick-hitch for fast and easy attachment and demounting.



Mechanical hitch

A mechanical 3 point seed drill hitch is available for conventional seed drills.





F35 - HEAVY HIGH PERFORMANCE

DESIGNED FOR TRACTORS UP TO 350HP*

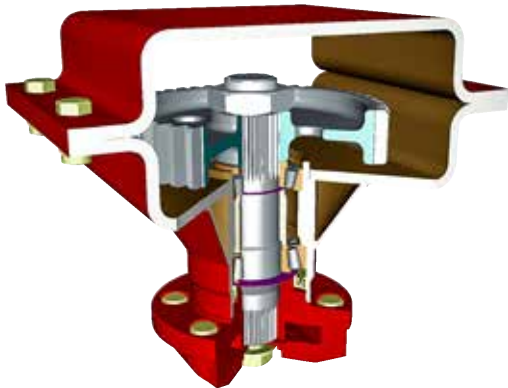

The Kverneland foldable power harrows F35 (4.5 – 6.0m) offers maximum performance with narrow transport abilities. Not only does the 350HP 3-speed gearboxes allow for the biggest tractors but also the rest of the construction is designed for maximum durability – even in combination with the seed drill equipment from Kverneland. A heavy-duty headstock and a robust transmission system ensure effective and safe operation. The advanced parallelogram hydraulic depth control system guarantees a perfect seedbed.

Rear rollers can be chosen from a complete range. Linked to the power harrow via parallelograms, the roller frame remains at the same angle when changing working depth of the machine. A real advantage when combining the power harrow with a DF1 or DF2 coulters bar: The coulters bar is fitted directly to the roller frame and provides – once adjusted – constant sowing depth, no matter what working depth the power harrow is being set. Also the rear levelling bar is linked to the roller and does not require additional adjustment when changing working depth of power harrow.

The upper half of the trough is made from 10mm steel plate. In order to give the F35 the strongest design and to enable it to withstand the toughest of conditions, the trough base is also made from 10mm steel plate. The welded conical bearing housings give highest strength to the overall trough. The heavy-duty tine carrier shafts are 60mm diameter with the conical bearings that have large enough dimensions to cope with tough and stony conditions.

*up to 400HP with an optional 2-speed gear box.

Hydraulic functions management

The foldable machines (F30 and F35) can be equipped with a control panel that allows the management of 5 different functions from the tractor cab by using just one double acting spool, available as an option.



On the foldable Kverneland power harrows the main gear distributes the force to the sides. On each side is a gearbox separately overload protected which ensures a robust driveline up to 350HP. The rotor speed setting varies from 336 to 450rpm at 1000rpm PTO shaft. The F35 is equipped with a change gearbox.



F30 - STRENGTH SELF-SUPPORTING DESIGNED FOR TRACTORS UP TO 300HP

The trough of the Kverneland foldable power harrow NG-H 101 F30 is self-supporting and does not require any lateral frame. This saves weight and gives a tidy look to the machine. Each side of the machine has its own gearbox and overload protection. For optimum performance the trough design provides a high clearance of 95mm between the tine holder and trough bottom. Crop residues and stones can thus enter the machines easier. The F30 power harrow is available in working widths from 4.0 to 6.0m.

Innovative and robust trough concept

The tine drive is conically beared, the bearing housing is firmly connected to the trough. By a simple and clear design the F30 trough offers excellent performance with a limited weight. Double conical bearings and rotor shaft of 50mm diameter in combination with removable tine holders and Quick-Fit tines guarantee high reliability and very low maintenance requirements.

The side sections are folded with one heavy cylinder. During work, the side parts can oscillate freely around the pivot point of the suspension.





S SERIES: COMPACT AND ROBUST DESIGNED FOR UP TO 250HP



A heavy-duty power harrow for all kinds of operations in all types of soil conditions. Robustly designed for use on tractors up to 250HP, with the Kverneland heavy-duty trough design and Quick-Fit tines the S series is the right solution for large farms and farm contractors.

The standard gearbox with a rotor speed of 298rpm is fitted with replaceable gears. Due to different soil conditions it is important to control the rotor speed. Therefore, additional gear sets to achieve 365rpm or 435 rpm are available as an option. Outer parallelogram-guided side deflectors with overload protection allow smooth operation and a ridge free soil surface, even when working in the most difficult conditions.

The S series is equipped with Quick-Fit tines as standard. These are secured by a special pin and clip mounted in the tine holder. Tine replacement is therefore very easy without the need of tools. Depending on soil conditions, forward active tines are available with more aggressive action. For optimum performance in difficult soil conditions, the trough design provides a large clearance between the tine holders and the trough bottom. This allows large amounts of residue and stones to pass freely without blocking.





H SERIES: HIGH CLEARANCE AND VERSATILE DESIGNED FOR TRACTORS UP TO 180HP

The robust medium-sized power harrow for effective operation in most conditions. By using a double bending sandwich section for the trough, it has been possible to increase its strength, making it self-supporting without increasing the weight whilst keeping a clean and tidy design. Main features like the rotor distance of 25cm, the double conical bearing, heavy-duty headstock and the modular tine carrier have been considered too.

Two profiled 6mm plates ensuring precise rotor spacing, high bending resistance of the 140 x 400mm trough. Tine shaft of 50mm with two large conical bearings, Ø 45mm and Ø 50mm with a distance of 55mm and 40mm gears and an ample clearance of 95mm between the trough bottom and the tine holder ensure good soil flow and allow surface residues to pass easily through the machine.

Tine dimension

15 x 330mm





M SERIES: POWERFUL AND RELIABLE DESIGNED FOR TRACTORS UP TO 140HP



The Kverneland M series is a medium-sized power harrow for tractors up to 140HP. It is the lightest model in the Kverneland power harrow range but not only the heavy-duty headstock follows the design concept of the robust S series but also the self-supporting trough construction, as well as the optional 'Quick-Fit' tine holders and double conical bearings offer the optimum performance.

The trough of the M series consists only from one bended part which is bolted on top. There is no welding which increases stability especially in combination with a seeder e.g. e-drill compact. Screws of the shaft are protected inside the gear case. The bended bolted plate together with the supporting reinforcement plate form the 140 x 400mm trough. Two conical bearings, with a large distance as well as a rotor clearance of 98.25mm between the trough bottom and the tine holder provide high stability.

Tine dimension
12 x 280mm



THE NEED FOR CONSOLIDATION REDUCES THE RISK OF EROSION IN THE TOPSOIL

Rollers have been designed to ensure an efficient soil compaction to reduce the soil porosity and limit evaporation in dry conditions but also to prepare an optimal seedbed as a good start for perfect growth and high yields.

The rollers are parallelogram guided. On folding power harrows, hydraulic depth adjustment is standard. Spacer stops above the movement of the cylinder. The parallelogram suspension has the advantage that the working angle of the roller remains constant even when the depths change e.g. important for cracker rollers. Combined with a coulter bar which is mounted on the roller frame, the depth control is independent of the power harrow.

The roller on a power harrow is an elementary tool with different tasks:

- Supporting the exact working depth of the machine is especially in light conditions.
- Optimal soil to seed/root contact to enable efficient nutrient transfer.
- Breaking of clods in order to have a fine seedbed but at the same time keeping the soil structure for reduced soil erosion, as the soil is both structured and stable.
- Improved drainage and water infiltration, especially important in wet years when a good, consolidated soil structure ensures access to plant root systems for water, air and nutrients.
- No separation or raising of straw and residues. Minimal moisture loss, is especially important in dry years when crops which lack moisture suffer badly.
- Reliable working without stick of the soil surface by slipping. Easy maintenance and cleaning.

Cracking performance.



Work done with an Actipack roller: left side skids lifted up (not active), right side skids down in action.



CONSOLIDATION

ROLLERS FOR ALL TYPE OF SOIL



MEDIUM TO HEAVY

Actipack Ø 560mm - 205 kg/m

- The Actipack roller displays its superb working qualities especially on medium to heavy soils and also in wet, stony and sticky conditions thanks to the independent skids and knives.
- The cutting discs break the larger clods whilst the adjustable knives cut the remaining clods resulting in optimal clod breakdown and fine seedbed preparation.
- If the knives are out of work position, the roller leaves a rough weatherproof surface which protects the top layer and prevents wind or water erosion.
- Scrapers between the discs support the cleaning effect especially in sticky conditions.
- Results like an active soil working tool.



The ring and shoulder angle design of the Actipack roller provides consolidation to depth without tightening up surface aggregates. Provides good weathering effect and transition of moisture through profile.



MEDIUM TO HEAVY

Cracker Packer Ø 550mm - 200kg/m

- Real stripe-wise reconsolidation (12.5cm) in front of seed coulters – only 50% of the soil surface is rolled.
- Good absorption of water.
- Sufficient soil left loose for covering of seeds.
- Optimum performance on medium to heavy soils.
- Good crumbling effect on especially on heavy soils.
- Smooth rings and passive-angled knives – no blocking when used in mulch conditions.

- Offering all plants the same access to nutrients, moisture and light.
- Finer soil particles are deposited in the lower level of the tilth to promote rapid and uniform germination.
- Prevent loss of moisture whilst the coarser clods are kept on the surface in order to reduce the risk of surface capping.



LIGHT TO MEDIUM TO HEAVY

Actiline ø 550mm - 185kg/m

- Trapezoidal roller with relatively narrow crest width of 40mm.
- Stripe-wise consolidation and V shape furrow in front of the CX-II seed coulter bar for a perfect seed placement and even field emergence.
- Supporting water holding capacity and oxygen exchange.
- Optimum performance on light to heavy soil.
- Good carrying capacity with full self-cleaning effect.
- Crests support the constant drive of the roller and avoid slip in light or tough and wet conditions.
- Two different ring distances of 12.5cm and 15cm.
- Carbide-coated scrapers on request.
- Standard or EURO-CONNECTION (15cm version excl. with EURO-CONNECTION).



LIGHT TO MEDIUM TO HEAVY

Tooth Packer roller ø 575mm - 160kg/m

- Optimum performance on medium to heavy soils.
- Good carrying capacity.
- Good self-cleaning effect.
- Central adjustable scraper bar with independently adjusted scrapers.
- Carbide-coated scrapers on request.
- Most versatile roller – especially as part of heavy power harrow/seed drill combinations.



LIGHT TO MEDIUM

Cage roller ø 550mm - 90 kg/m

- 10 bars for a good loading capacity and operation in wet conditions.
- Suitable for light to medium soils and dry working conditions e.g. seed bed preparation for potato-planting.
- Included in the front-mounting kit for additional depth control in front of the machine.

SAFE ON THE ROAD EASY TO CONVERT



Quick in the field and quick on the road – easy conversion from working to transport position from the tractor cab.

The two-part hydraulic folding gives a transport width of max. 2.50m resp. 2.90m with DF2 coulters bar. The hydraulic suspension ensures smooth running and safe road transport. Lighting equipment is available as an option.



* see local road regulations.



Powering into seedbed production

Faced with a wide variety of soil types, Northants contracting firm P&R Burbage makes the most of a Kverneland NGH power harrow.

“There’s nothing quite like it when preparing seedbeds for grass and maize,” explains Pete, who runs the business with his brother, Rich. “They are so versatile, and can remove wheelings, fill in as needed, and give you a great tilth.”

Their power harrow of choice is a F30 model packing a 6m working width, and was supplied along with a six-furrow vari-width plough.

“Bigger kit does buy you time, and going to a 6m folding power harrow to replace a 4m model with end-tow was a no-brainer,” he says. “It has hydraulic depth control, and compliments a hydraulic top link which we choose for every tractor, and is a must for our business when you’re dealing with changes in soil type.”

“With this system, we can lift the rear roller, bury the harrow and move soil as required. Then we can fold up and go.”

Foreman Andy Russell says the power harrow doesn’t leave ridges thanks to heavy duty spring-loaded side-deflectors, and the toothed packer roller provides a good firm finish in almost any soil type encountered.

“We’ve had the Kverneland power harrow for three seasons, and it’s never missed a beat,” says Andy. “It covers around 900 acres each spring, and will probably handle 500-600 acres every autumn.”

“And with quick-fit tines, it is easy to swap wearing metal when needed,” he says. “The PTO-shaft to the central gearbox can be tricky to grease, but other than that, it’s a very simple and robust machine, that does exactly what we want. We’d certainly have another.”

ORIGINAL PARTS & SERVICE

LET'S FOCUS ON YOUR BUSINESS

ORIGINAL
PARTS

- 
- ① LONG LASTING - HIGH QUALITY SPARE PARTS
 - ② OVER 100 YEARS OF PARTS KNOWLEDGE
 - ③ SUPPORT FROM A WIDE NETWORK OF DEALERS
 - ④ 24/7 SPARE PARTS SERVICE
 - ⑤ HIGHLY SKILLED DEALER TECHNICIANS

MYKVERNELAND

SMARTER FARMING ON THE GO

A personalised online platform tailored to your machine needs

With MYKVERNELAND you will benefit from easy access to Kverneland's online service tools.

First hand access to information on future developments and updates, Operator and spare parts manuals, FAQs and local VIP offers. All info gathered in one place.



REGISTER YOUR PRODUCT NOW:
MY.KVERNELAND.COM

TECHNICAL DATA

Model	M series		H series			S series				F30				F35		
Maschine type	rigid		rigid			rigid				fold				fold		
Working width (m)	2.5	3.0	3.0	3.5	4.0	3.0	3.5	4.0	4.5	4.0	4.5	5.0	6.0	4.5	5.0	6.0
Transport width (m)	2.5	3.0	3.0	3.5	4.0	3.0	3.5	4.0	4.5	2.5	2.5	2.5	2.5	2.5	2.5	2.5
Trough dimension (mm)	140 x 400		165 x 400			200 x 400				150 x 400				150 x 400		
PTO input speed (rpm)	540 or 1,000		1,000			1,000				1,000				1,000		
Overload protection on PTO shaft (Nm)	2,000		2,000			2,500				2,500				2,500		
Number of rotors	10	12	12	14	16	12	14	16	18	16	18	20	24	18	20	24
Standard rotor speed 540rpm (rpm)	311		-			-				-				-		
Standard rotor speed 1000rpm (rpm)	351		336			298				336				246, 326 and 387 (3-speed)		
Optional rotor speed 540rpm (rpm)	358		-			-				-				-		
Optional rotor speed 1000rpm (rpm)	351		362 and 450			365 and 435				362 and 450				326 and 387 (2-speed)		
Tapered bearing distance (mm)	70		84.5			110.5				84.5				110.5		
Rotor clearance (mm)	98.25		90.5			100				90.5				147		
Number of tines	20	24	24	28	32	24	28	32	36	32	36	40	48	36	40	48
Tine dimension (mm)	12 x 280		15 x 330			18 x 330				15 x 330				18 x 330		
Quick-Fit tines	○		●			●				●				●		
Active tines	-		○			○				○				○		
3-point Linkage: Top	CAT 2/CAT 3		CAT 2/CAT 3			CAT 2/CAT 3				CAT 3				CAT 3		
3-point Linkage: Low	CAT 2/CAT 3N/CAT 3		CAT 2/CAT 3N/CAT 3			CAT 2/CAT 3N/CAT 3				CAT 3				CAT 3		
Depth adjustment	manual		manual			manual				hydraulic				hydraulic		
Rear levelling bar	○		○			○				○				○		
Track eradicator	○		○			○				○				○		
Roller offering	Cage roller (ø 550mm), Tooth Packer roller (ø 575mm), Actiline roller (ø 550mm), Cracker Packer roller (ø 550mm), Actipack roller (ø 560mm)															
Ready to carry or integrate seeding eq.	○		○			○				○				○		
Lighting set	○		○			○				○				○		
Total weight (kg)*	1,350	1,550	1,610	1,850	2,100	1,900	2,080	2,290	2,560	3,040	3,160	3,650	3,990	3,710	3,980	4,640
Minimum power requirement (kW/HP)	51/70		63/85			74/100				96/130				103/140		
Maximum power requirement (kW/HP)	103/140		132/180			184/250				221/300				257/350 (optional with 400HP gear)		

* Approx. weight with levelling bar, tooth packer roller Ø 575mm and PTO shaft approx.

● Standard equipment ○ Option - Not available

Information provided in this brochure is made for general information purposes only and for worldwide circulation. Inaccuracies, errors or omissions may occur and the information may thus not constitute basis for any legal claim against Kverneland Group. Availability of models, specifications and optional equipment may differ from country to country. Please consult your local dealer. Kverneland Group reserves the right at any time to make changes to the design or specifications shown or described, to add or remove features, without any notice or obligations. Safety devices may have been removed from the machines for illustration purposes only, in order to better present functions of the machines. To avoid risk of injury, safety devices must never be removed. If removal of safety devices is necessary, e.g. for maintenance purposes, please contact proper assistance or supervision of a technical assistant. © Kverneland Group Soest GmbH

WHEN FARMING MEANS BUSINESS

kverneland.com